

FIRE CONTROL PANEL MAG 8plus



INSTALLATION AND OPERATION MANUAL

CE1293

Contents

GUARANTEE	3
1. GENERAL INFORMATION	4
2. TECHNICAL SPECIFICATIONS	4
2.1 General Technical Specifications of MAG 8plus.....	4
2.2 General Technical Specifications of Relay Module MR8.....	5
3. INSTALLING MAG 8plus	6
3.1 Wall Mounting.....	7
3.2 Flush Mounting.....	7
3.3 Configuration of the Basic Modules.....	8
3.4 Control Module.....	9
3.5 Main Power Source.....	10
<i>Connecting of the Main Power Source</i>	10
<i>Connecting to the Battery</i>	10
3.6 4-Zone Expander.....	11
<i>Connecting of Additional 4-Zone Expander</i>	11
3.7 4-Sounder Expander.....	12
<i>Performance and Connecting of 4-Sounder Expander</i>	12
4. CONNECTING	
4.1 Relay Module MR8.....	13
4.2 Repeater Panel.....	15
4.3 Class Change Mode.....	16
4.4 Connecting the Zone and Sounder Circuits.....	16
5. SYSTEM PROGRAMMING	
5.1 Sounder Delay.....	18
5.2 Double Action Mode.....	19
5.3 Instant Action Mode.....	19
5.4 Master Panel Mode.....	20
5.5 Repeater Panel Mode.....	20
5.6 Single Panel Mode.....	20
6. OPERATION INSTRUCTIONS	
6.1 Initial Start-up of MAG 8plus.....	21
6.2 Front Panel.....	21
6.3 Buttons.....	22
6.4 LED Indication.....	22
6.5 Sound Signal.....	23
6.6 Service Modes.....	23
7. INDICATION	
7.1 Faults Indication.....	26
7.2 Indication of the Operation Modes.....	27
GENERAL CONNECTION CIRCUIT OF MAG 8PLUS	28
FIRE ALARM RECORD	29
SERVICE RECORD	30
FIRE ALARM EVENT LOG	30
SPARE PARTS KITS	31

GUARANTEE

During the guarantee period the manufacturer shall, at its sole discretion, replace or repair any defective product when it is returned to the factory. All parts replaced and/or repaired shall be covered for the remainder of the original guarantee, or for ninety (90) days, whichever period is longer. The original purchaser shall immediately send manufacturer a written notice of the defective parts or workmanship, which written notice must in all cases be received prior to expiry of the guarantee.

INTERNATIONAL GUARANTEE

Foreign customers shall enjoy the same guarantee rights as those enjoyed by any customer in Bulgaria, except that manufacturer shall not be liable for any related customs duties, taxes or VAT, which may be payable.

GUARANTEE PROCEDURE

This guarantee will be granted when the appliance in question is returned. The manufacturer shall accept no product whatsoever, of which no prior notice has been received.

CONDITIONS FOR WAIVING THE GUARANTEE

This guarantee shall apply to defects in products resulting only from improper materials or workmanship, related to its normal use. It shall not cover:

- Damages resulting from improper transportation and handling;
- Damages caused by natural calamities, such as fire, floods, storms, earthquakes or lightning;
- Damages caused by incorrect voltage, accidental breakage or water; beyond the control of the manufacturer;
- Damages caused by unauthorized system incorporation, changes, modifications or surrounding objects;
- Damages caused by peripheral appliances unless such peripheral appliances have been supplied by the manufacturer;
- Defects caused by inappropriate surrounding of installed products;
- Damages caused by failure to use the product for its normal purpose;
- Damages caused by improper maintenance;
- Damages resulting from any other cause, bad maintenance or product misuse.

In the case of a reasonable number of unsuccessful attempts to repair the product, covered by this guarantee, the manufacturer's liability shall be limited to the replacement of the product as the sole compensation for breach of the guarantee. Under no circumstances shall the manufacturer be liable for any special, accidental or consequential damages, on the grounds of breach of guarantee, breach of agreement, negligence, or any other legal notion.

WAIVER

This Guarantee shall contain the entire guarantee and shall be prevailing over any and all other guarantees, explicit or implicit (including any implicit guarantees on behalf of the dealer, or adaptability to specific purposes), and over any other responsibilities or liabilities on behalf of the manufacturer. The manufacturer does neither agree, nor empower, any person, acting on his own behalf, to modify or alter this Guarantee, nor to replace it with another guarantee, or another liability with regard to this product.

UNWARRANTED SERVICES

The manufacturer shall repair or replace unwarranted products, which have been returned to its factory, at its sole discretion under the conditions below. The manufacturer shall accept no products for which no prior notice has been received.

The products, which the manufacturer deems repairable, will be repaired and returned. The manufacturer has prepared a price list and those products, which can be repaired, shall be paid for every repaired appliance.

The closest equivalent product, available at the time, shall replace the products manufacturer deems un-repairable. The current market price shall be charged for every replaced product.

ATTENTION

This manual contains an information about the limitations in using and operation of the product, as and information about the limits in the responsibility of the manufacturer. Please read the operation manual carefully before starting the installation.

1. GENERAL INFORMATION

The MAG 8plus is a conventional microprocessor fire control panel, designed according to EN54 Standard requirements. The panel provides for monitoring and reporting fire events in up to 16 separate zones, depending on the installed configuration.

The MAG 8plus must be installed according to the Fire Alarm Installation Regulations, mandatory for the territory of the respective country. The electrical power supply to the panel must be isolated and must not be capable of being accidentally switched off. The power switch-off board should display a clear FIRE ALARM - DO NOT SWITCH OFF label.

2. TECHNICAL SPECIFICATIONS

2.1 General Technical Specifications of MAG 8plus

- **Maximum number of detectors per zone:**
 - Up to 32 conventional detectors with consumption < 200 μ A at a normal mode;
 - Unlimited number of manual call points.

- **Thresholds for zone conditions:**
 - 0 \div 2 mA
 - 2 \div 10 mA
 - 10 \div 110 mA
 - > 110 mA
 - Open circuit fault condition.
 - Normal condition.
 - Fire alarm condition.
 - Short circuit condition.

- **Power Supply:**
 - Main Power Supply ~ 230V AC \pm 10%
2A Fuse, T-Type.

 - Stand-by Power Supply 1 Accumulator battery 12V/ 18Ah
Dimensions - 167x181x76mm
Voltage Output - $U_{\text{CHARGE}} = 13,8\text{V}$
Current Output - $I_{\text{MAX}} = 2\text{A}$
7A Fuse, Resettable (PTC)
Battery connection: with a flat terminal lug $\varnothing 5\text{mm}$

- **Consumption from 230V in normal working mode and a fully charged battery:**
 - At 4 zones (1 Zone Expander) 2,1VA
 - At 16 zones (4 Zone Expanders) 4,2VA

- **Consumption from the battery at mains power supply failure in normal working mode:**
 - With connected 1 Zone Expander 130mA
 - With connected 4 Zone Expanders 260mA

- **Consumption from the battery in Fire alarm condition:**
 - At 1 Zone Expander, Fire in 1 zone 330mA
 - At 1 Zone Expander, Fire in 4 zones 720mA

- **Outputs:**
 - Sounder circuits SND1 \div SND4 (control module) +24V/ 0.3A
Resettable (PTC) Fuse

- Sounder circuits SND1÷SND4 (4-Sounder Expander) +24V/ 0.15A
Fuse, Resettable (PTC)
- Fault Relay, volt free changeover contacts* +12V/ 1A or 24V/ 0.5A
 $U_{MAX} = 125V; I_{MAX} = 2A$
- Fire Relay, volt free changeover contacts* +12V/ 1A or 24V/ 0.5A
 $U_{MAX} = 125V; I_{MAX} = 2A$

* **Note:** These functions may not be used to provide any “Options with requirements” as specified in EN54-2.

- Auxiliary output +24V DC/ 0,3A
Fuse, Resettable (PTC)

▪ **Cabling of the main power supply:**

- Recommended wires cross section 1.5mm²
- Terminal maximum wire diameter Ø2.5mm

▪ **Environment:**

- Working temperature -5 ÷ +40°C
- Storage temperature -20 ÷ +60°C
- Humidity Up to 93% (non condensing)

2.2 General Technical Specifications of Relay Module MR8

- **Number of relays:** 8
- **Power supply:** 24V
- **Current consumption in normal condition:** 8mA
- **Additional current consumption for every relay switched ON:** 10mA
- **Maximum ratings of volt-free changeover contacts:** 12V/ 1A or 24V/ 0.5A
- **Maximum voltage:** 125V
- **Maximum consumption:** 2A
- **Cabling:**
 - Recommended wires cross section 1.5mm²
 - Terminal maximum wire diameter Ø2.5mm
- **Environment:**
 - Working temperature -5 ÷ +40°C
 - Storage temperature -20 ÷ +60°C
 - Humidity Up to 93% (non condensing)

WARNINGS:



Prior to connecting the MAG 8plus Fire Alarm Panel, perform a thorough test of the all wiring integrity of the entire system.
Should a fault arise during installation and connection, which cannot be removed, stop the installation and call the producer or his regional authorized representative!

TECHNICAL SUPPORT HELP

TEL.: +359 (2) 9694 700

3. INSTALLING MAG 8Plus

- Select the best location for the panel away from sources of heat, environmental dust and potential water ingress, with an ambient temperature of between -5°C and $+40^{\circ}\text{C}$, Figure 1.
- Undo the two secure bolts - Figure 2. Use the instrument supplied for the purpose in the set (hexagonal tool No. 2).
- Open the front panel and disconnect the earth cables: from the 230 V clamps, from the metal bottom clamps and from the chassis.
- Disconnect the indication ribbon cable.
- Remove the front panel by undoing the screws of the hinges - Figure 3. (**NB.** *The screws at the metal bottom can also be undone. What is special here is that there are two plastic pads under the every hinge. These pads need to be placed back again under the hinges when mounting the front panel.*)
- Select the input openings for the cables and place a plastic cap, provided with the panel accessories, on those which are not going to be used, see Position 9 from the spare parts kit on page 31.
- Perform an exposed or flushed mounting (option) - see items 3.1 and 3.2.
- Run all external cables into the box to establish connection **but do not connect them at this stage yet. Run the mains cable through the chosen opening but keep it away from the low voltage wirings.**
- Connect the mains supply and earth to the main terminal block but **do not** switch the main electrical supply on at this stage.
- Position the battery and secure it with the clamp - Figure 9, Position 1.
- Place the plastic lightpipe (see Positions 7, 11 and 15, page 31), provided with the spare parts kit, at their designated locations on the main module, zone and/or sounder expanders.
- Connect the zone and sounder circuits and program the panel according to the specific application.
- Mount the front panel back onto the hinges and connect the indication ribbon cable and the earth cables: to the 230 V clamps, to the metal bottom clamps and to the chassis.
- After all system programming and testing operation are complete, screw both secure bolts with the help of the hexagonal tool supplied.

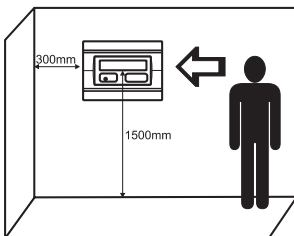

Figure 1.

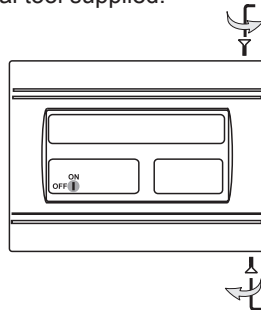

Figure 2.

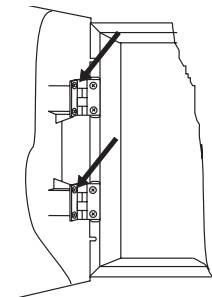

Figure 3.

3.1 Wall Mounting

- Use the template supplied to determine the openings of the metal bottom onto the wall - Figure 4.
- Drill $\text{Ø}6\text{-}8\text{mm}$ diameter openings in the wall and fix the box using the provided anchors and screws (Positions 2 and 4, page 31) - Figure 5.

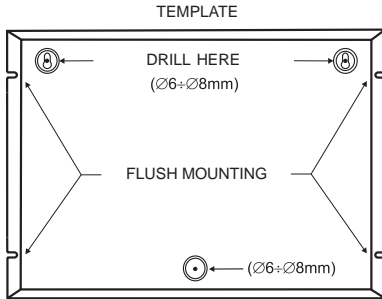

Figure 4.

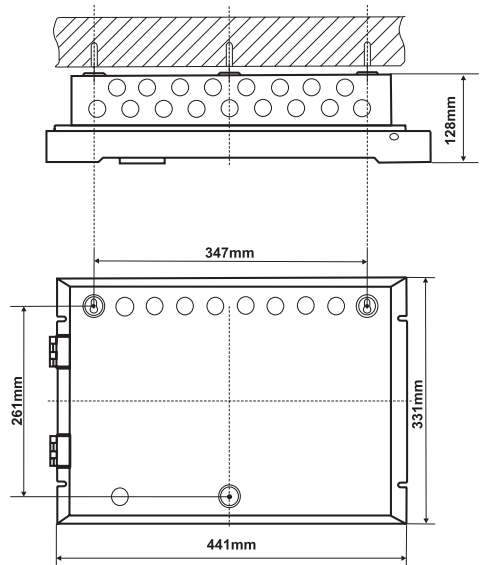

Figure 5.

3.2 Flush Mounting (option)

The accessory set provided contains two special hangers for flushed wall mounting (position 20, page 31) of the fire alarm panel on 25 mm thick drywall.

- Use the dimension shown in Figure 6 to draw and cut out the mounting openings in the drywall.
- Attach the hangers to the internal side of the wall and fix them with the screws (Position 19, page 31), as shown in Figure 7, Position 1.
- Run all external cables in the box and then place it into the mounting opening. Fix the bottom using the mounting screws and washers (Positions 17 and 18, page 31) - Figure 7, Position 2.

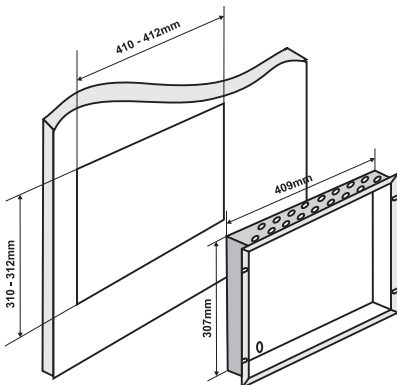

Figure 6.

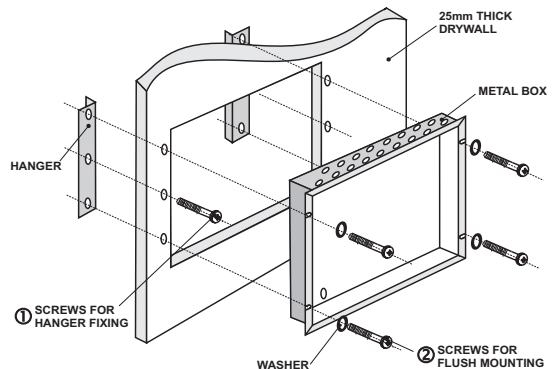

Figure 7.

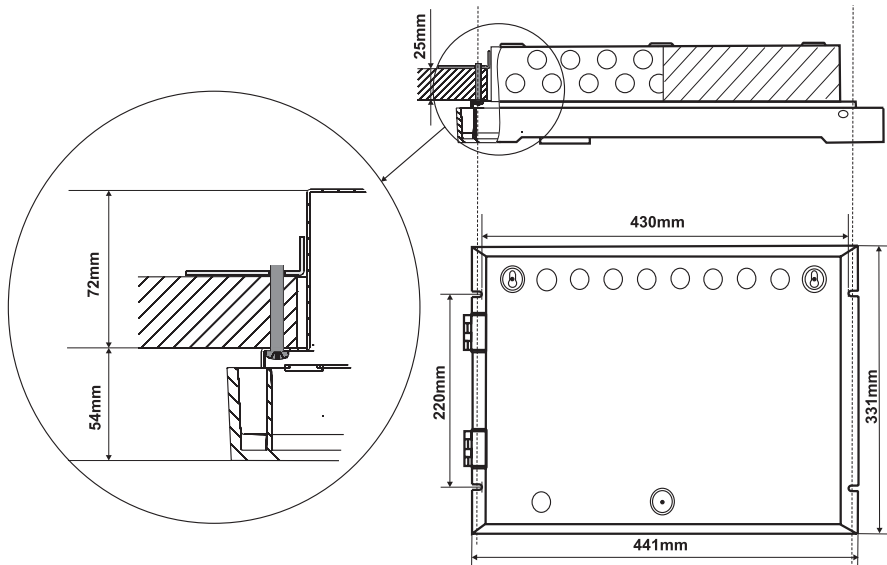

Figure 8. Flush mounting holes.

Main view of the fixed to the wall hangers and the bolts supporting the metal box.

3.3 Configuration of the Basic Modules

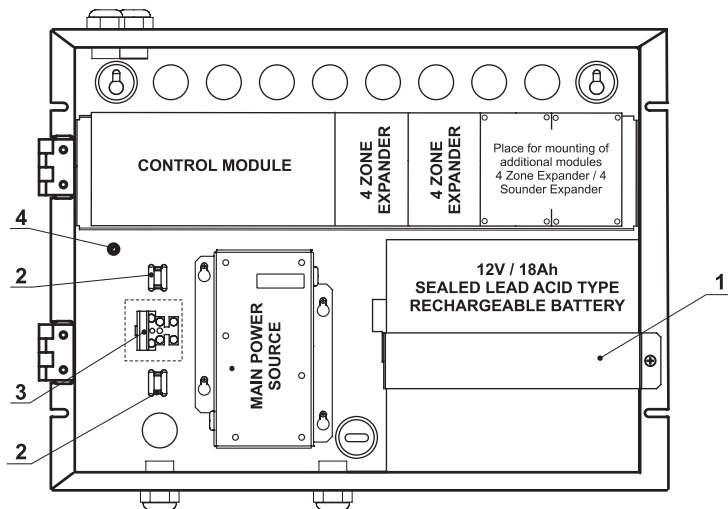

Figure 9.

- 1 - Metal clamp for supporting the battery.
- 2 - Clamp for supporting the main power supply cable.
- 3 - Terminal for connecting between the mains power supply and the power source. T-type fuse 2A (Position 3, page 31).
- 4 - Earthing point.

3.4 Control Module

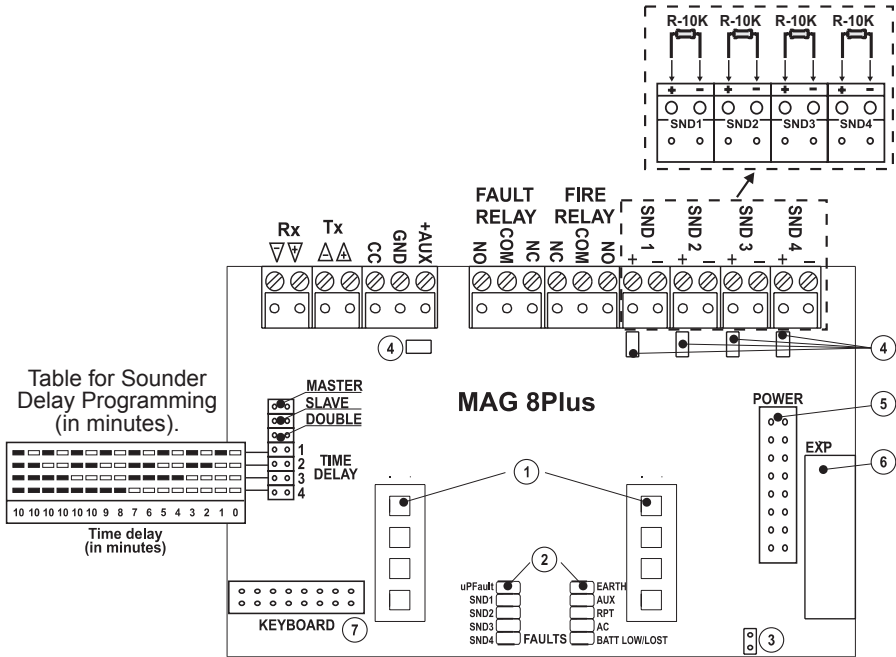

Figure 10.

- **Rx/Tx** - Terminals for connecting of Repeater, Relay Module or a combined connection between them (see items 4.1 and 4.2);
- **CC** (Class change) - Terminal for connecting of a switch (see item 4.3);
- **GND** - Grounding;
- **+AUX** - Auxiliary output, +24V DC / 0,3A;
- **FAULT RELAY** - Fault Relay, +12V / 1A or +24V / 0,5A;
- **FIRE RELAY** - Fire Relay, +12V / 1A or +24V / 0,5A;
- **SND 1 ÷ SND 4** - Sounder outputs, +24V / 0,3A; Mount the resistors R-10K from the supplied spare parts kit (position 1, page 31) to the sounder terminals;
- **DOUBLE** - Double Action Mode (see item 5.2);
- **MASTER** - Master Panel Mode (see item 5.4);
- **SLAVE** - Repeater Panel Mode (see item 5.5);
- **TIME DELAY** - Sounder Delay Programming.

- ① - LED Indication of the operation modes, lightpipe mounted (Position 7, page 31);
- ② - Faults LED indication, see item 7.1;
- ③ - Jumper for enable/disable Earth Fault Indication;
- ④ - Resettable (PTC) fuses;
- ⑤ - Connector for connecting the main power source;
- ⑥ - Connector for connecting 4-zone / 4-sounder expander;
- ⑦ - Connector for connecting the control panel keypad.

3.5 Main Power Source

Connecting of the Main Power Source

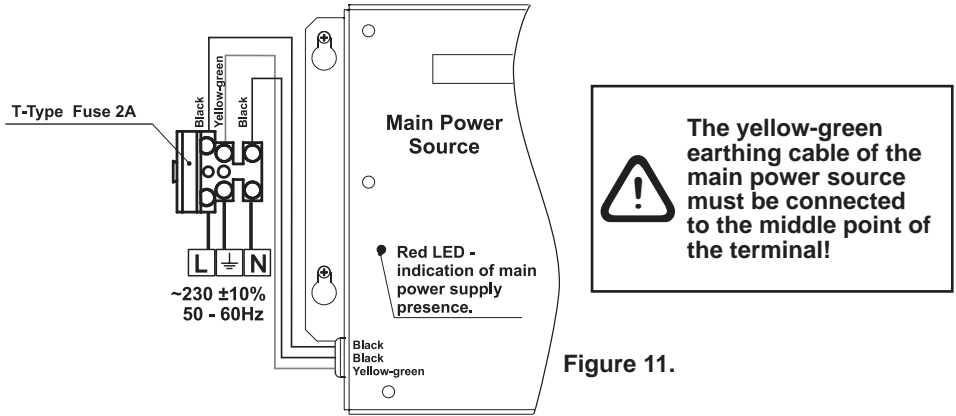

Connecting to the Battery

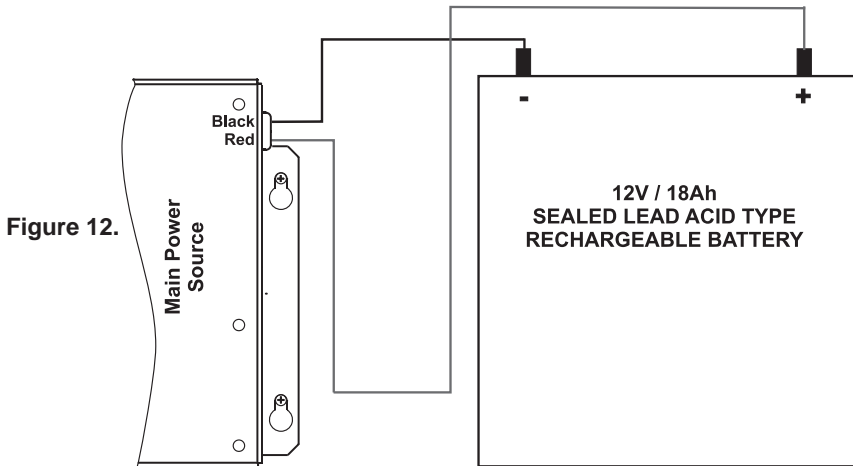

Attention: It is possible that the battery might not be charged at the panel initial start-up. In this case the **BATT LOW/LOST** at the control module and the **GENERAL FAULT** at the front panel will light on until the battery will be charged up to the required level.

3.6 4-Zone Expander

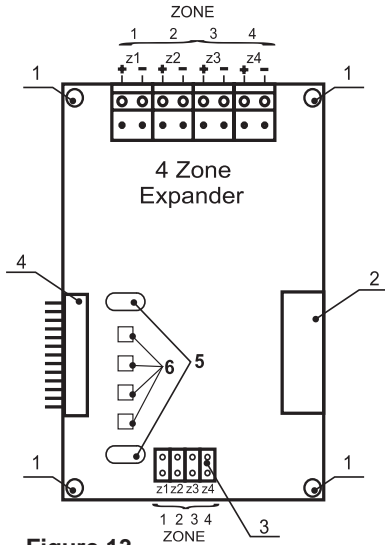

Figure 13.

• 1 - Mounting holes for fixing the expander to the chassis.

• 2 - Connector for connecting of additional 4-zone / 4-sounder expander.

• 3 - Jumpers for Instant action mode programming.

Example: To program ZONE1 in Instant action mode set a jumper on the z1 position.

• 4 - Connector for connecting:

a) To the control module, when the 4-zone expander is the first module in the panel configuration.

b) To a previous 4-zone expander;

• 5 - Mounting holes for placing a lightpipe for the front panel LED indication, see Position 11 of the additional components included, page 31.

• 6 - LEDs Zone status indication.

Connecting of Additional 4-Zone Expander

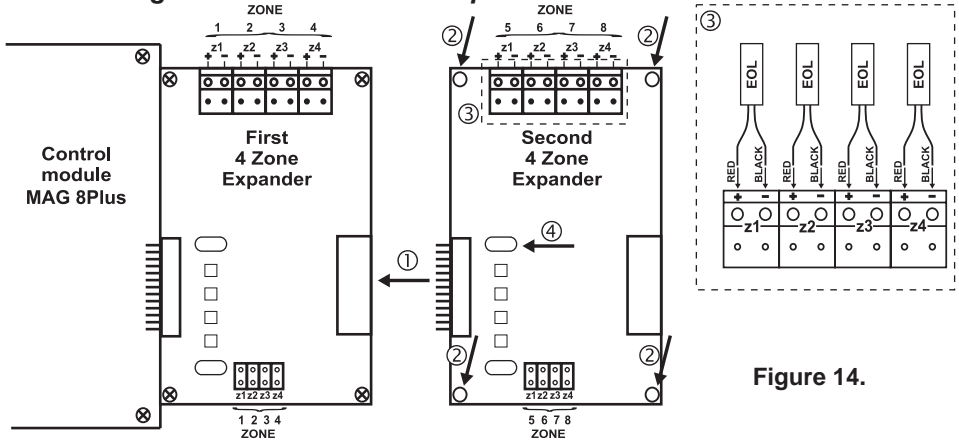

Figure 14.

• 1 - Connect the connectors of the expanders.

• 2 - Fix the second 4-zone expander with screws from the spare parts kit (position 10, page 31) to the metal box frame.

• 3 - Mount the EOL-modules from the supplied spare parts kit (position 12, page 31) to the zone expander's terminals as observe the polarity.

• 4 - Place the lightpipe (Position 11, page 31).



ATTENTION: Do not connect or disconnect the expander when the power is on! Before connecting or disconnecting the expander you SHOULD check whether the main and the stand-by power supplies are OFF!

The metal box of MAG 8plus can accommodate up to 4-zone expanders. To each zone can be connected up to 32 conventional detectors with consumption <math><200\mu A</math> at normal operation mode and unlimited number of manual call points.

3.7 4-Sounder Expander

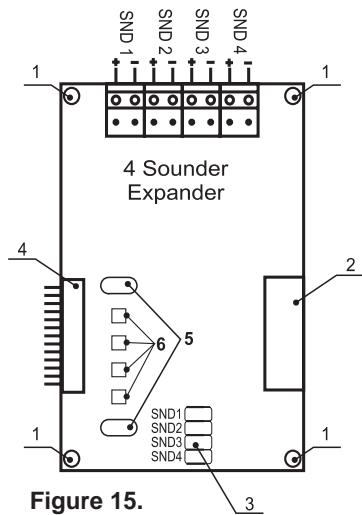

Figure 15.

- 1 - Mounting holes.
 - 2 - Connector for connecting of additional 4-sounder expander.
 - 3 - LED indication for troubles in the sounder circuits. In case of a trouble in any of the sounder circuit **SND1 - 4** the LED of the respective sounder circuit will light on together with **GENERAL FAULT** and **SOUNDER FAULT/DISABLE** indicators on the front panel.
 - 4 - Connector for connecting:
 - a) To a 4-zone expander.
 - b) To a previous 4-sounder expander.
 - c) To the control module.*
 - 5 - Mounting holes for placing a lightpipe for the front panel LED indication, Position 15, page 31.*
 - 6 - LEDs Sounder status indication.*
- * **Note: Just in case**, when the panel is in Repeater Mode (a jumper is set on the **SLAVE** position).

Performance and Connecting of the 4-Sounder Expander

There is a correspondence between the zone numbers and the sounders - ZONE 1 of the 4-zone expander corresponds to SOUNDER 1 of the 4-sounder expander, ZONE 2 to SOUNDER 2, and so on. In case of fire in ZONE 1, SOUNDER 1 will operate continuously and Sounders 2 ÷ 4 of the expander will be pulse activated - 2 sec. sound/ 2 sec. silent.

The method of adding of 4-sounder expander is analogical to that of adding a 4-zone expander module, see Figure 14. **Note:** At Step 3 mount the resistors R-10K from the supplied spare parts kit (position 16, page 31) to the sounder expander terminals.



ATTENTION: Do not connect or disconnect the expander when the power is on! Before connecting or disconnecting the expander you SHOULD check whether the main and the stand-by power supplies are OFF!



Note: Only a module of the same type can be added to the 4-sounder expander. For the proper performance of the fire alarm panel observe the connection sequence presented in Figure 16a. In case of improper connection (Figure 16b), an error signal will be generated when the power supply is switched on - the LEDs of the zones connected after the 4-sounder expander will begin to blink and the GENERAL FAULT LED remains permanently lit.

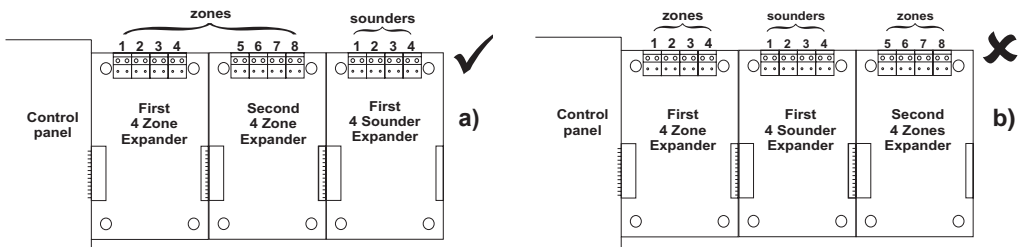

Figure 16.

4. CONNECTING

4.1 Relay Module MR8

MR8 is a supplementary module which is located outside the MAG 8plus Alarm Panel box. The MR8 contains 8 changeover contact relays.

When using all 16 zones, the MAG 8plus needs two relay modules.

The technical specifications of the MR8 module relays are described in item 2.2.

Configuring the MR8 outputs



Should zones numbered 1 to 8 be used, a jumper is set at outputs 1÷8 of the MR8 mother board; should the jumper be set at outputs 9÷16, zones numbered 9 to 16 will be used - Figure 17.

The MR8 relay contact type (normally closed or normally open) is determined by configuring the NO/NC outputs. Setting the jumper at the NO output will normally open the contact; setting the jumper at the NC output will normally close the contact - Figure 17.

Special jumper J1 - when this jumper is set, the first zone relay is activated by the module relays after the button  (see item 6.2) on the control panel is pressed upon an alarm event.

Performance of the MR8 Module Relays

The MR8 Relays are activated upon an alarm event (fire) in the respective zone they are connected to.

- If a sounder delay is set in the main control panel, this delay will also reflect on the relay activation of the first alarm - it shall delay by the same duration.
- The relay activation delay is eliminated by pressing the  button - the relay and the sounders are immediately enabled.
- Once a fire signal has been generated and there is a sounder delay set off, the following MR8 relays will be activated immediately.
- The activation of the respective relay is immediately after the sounders are activated. Where there is any delay, it shall apply only to the relay of the zone that first entered the alarm mode.
- The relay will restore its normal state only after the initial start-up of the control panel. Pressing the  button will not restore the relay.



In order to operate together with the MR8, the MAG 8plus Fire Alarm Panel must be in Master Panel mode - a jumper is set at the Master position.

The connecting between one Relay Module MR8 and Master Panel MAG 8plus is shown on Figure 18.

The connecting between two Relay Modules MR8 and Master Panel MAG 8plus is shown on Figure 19.

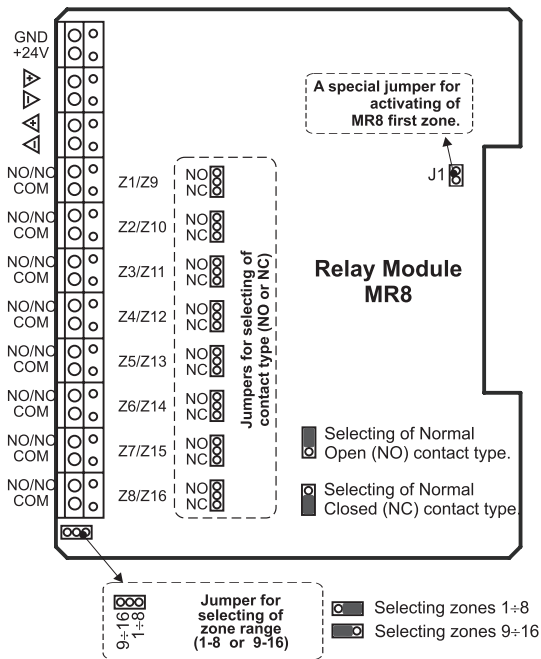

Figure 17.
Terminals and jumper configuration of MR8.

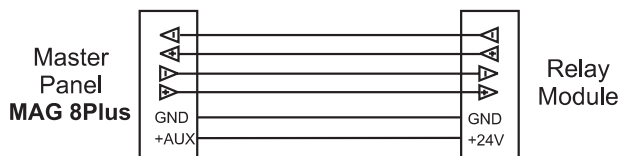

Figure 18.
Connecting between one Relay Module and Master Panel.

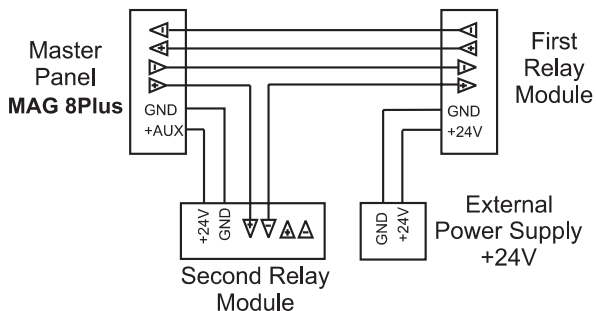

Figure 19.
Connecting between two Relay Modules and Master Panel.

4.2 Repeater Panel

A second MAG 8plus can be connected to the MAG 8plus Fire Alarm panel as Slave. The function of the Slave is to double the light and sound indication and the button control of the first panel at a distance up to 1000 m. For the purpose, to both of the panels have to be assigned specific priorities: The first fire alarm panel shall be the system Master and the second - Slave.

The Master panel is configured by setting a jumper on the **Master** position of the main module, and the Slave - with a jumper on the **Slave** position (see Figure 10).

Figure 20 shows the connection between the Master and Slave MAG 8plus panels.

Connecting of Repeater Panel

When adding a repeater panel in the fire system:

- Turn off the main and the stand-by power supplies.
- Connect the repeater to the first MAG 8plus - see Figures 20, 21 and 22.
- Set a jumper on the **Master** position of the main panel - see Figures 10 and 20.
- Set a jumper on the **Slave** position of the second panel - see Figures 10 and 20.
- Turn on the main and the stand-by power supplies of the Slave panel.
- Turn on the main and the stand-by power supplies of the Master panel.

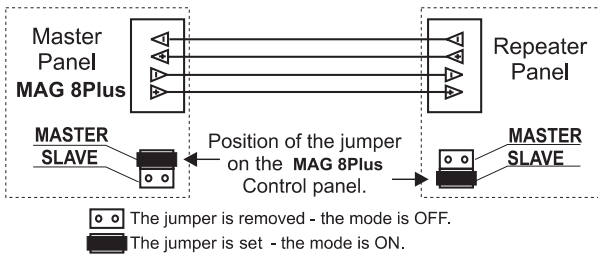

Figure 20.
Connecting between Repeater and Master Panel.

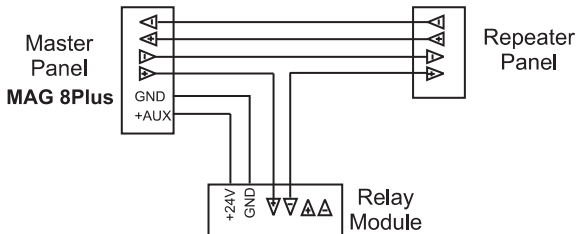

Figure 21.
Connecting between one Relay Module, Repeater and Master Panel.

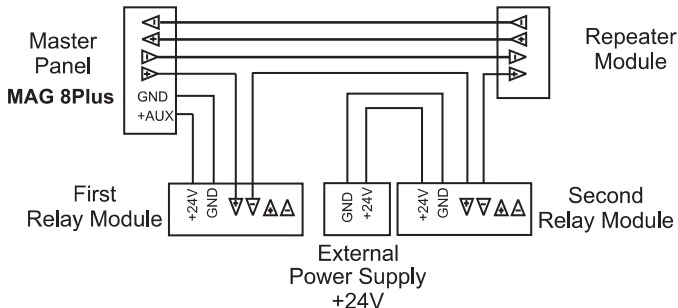

Figure 22.
Connecting between two Relay Modules, Repeater and Master Panel.

4.3 Class Change Mode

To use the class change function connect the terminals of a switch with normally open contacts to the **CC (Class Change)** clamps of the main module terminal (Figure 10). The working mode of the sounders will be:

- when the switch is pressed - one second sounder on, one second sounder off;
- when the switch is depressed - the sounder is off.

4.4 Connecting the Zone and Sounder Circuits



Verify the normal functioning of the panel before connecting circuits to zones and sounders:

- Connect the battery to the power unit terminals - Figure 12.
- Check the availability and condition of the fuse, a 2A T-type, located in the clamp for connecting the power unit to the main electric network.
- Turn on the main power supply.



In normal operation mode only the “POWER SUPPLY 230V” LED lights up on the front panel of the fire alarm station.

NOTE: In case other indicators are also lit and the internal buzzer has been activated:

- Disable the buzzer with the **SILENCE BUZZER**  button on the front panel.
- Check the mains fuse.
- Check the electrical connections within the station box.
- Check for any activated **FAULTS** LEDs of the main module, see Figure 10. Specify the faults according to the Faults Indication Table on page 26.
- Press the **RESET**  button (see item 6.2) on the front panel to reset the system.

Connecting the Zone Circuits

Up to 32 conventional fire detectors and an unlimited number of manual call points can be connected to each circuit. Figure 23 shows how to connect detectors within a zone.

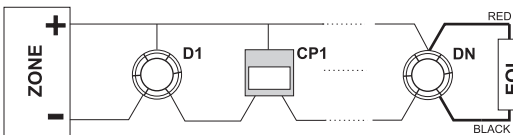

Figure 23. Connecting of detectors (D1÷N) and manual call points (CP1÷N) to the zone circuit.



Attention: During DOUBLE ACTION mode of operation, where the zone expander has NO jumper set for instant action of any zone on the terminal, ONLY detectors can be connected to its circuit. If a jumper has been set - detectors and call points.

Example: If there are call points connected in ZONE 1, for the system to function properly there must be a jumper set at its zone expander at z1 position, see also Figure 26.

In order to connect the zone circuits:

- Shut down the mains supply and disconnect the terminals of the power unit to the battery.
- One by one remove the EOL-modules from the 4-zone expander connecting clamps and fit them to the last detector of each of the circuits as observe the polarity - Figure 23.
- Connect each circuit to a separate zone on the terminal of the 4-zone expander.
- Connect the battery to the power source and apply mains power to the panel.



After powering up the panel should be in normal operation mode and the "POWER SUPPLY 230V" LED lights up on the front panel of MAG 8plus.

NOTE: If the **GENERAL FAULT LED** lights up and a fault indicator has been activated for one or more zones on the front panel, the problem lies with the connection of the circuits in these zones. Check the polarity of the connection of the devices and whether there is a detector removed from its base.

- Activate one or more detectors to each connected zone to verify that fire signals are generated and also that the panel operates correctly.

Connecting of FAULT and FIRE Relays

The relays with changeover contacts are intended for control of low voltage devices.



Attention: No mains power should be supplied to the clamps of the FAULT and FIRE relays. After the connection is established, test each of the circuits for external device control.

Connecting of Sounder Circuits

Figure 24 shows how to connect the sounders. One R=10K resistor is connected to the end of each circuit as shown in the diagram.

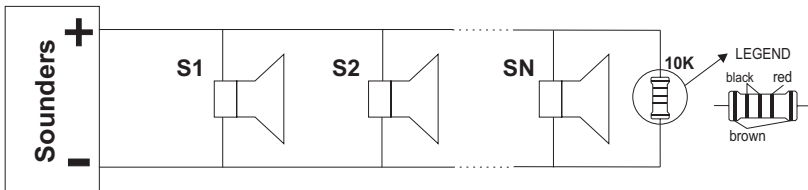

Figure 24. Connecting of sounders to SND1÷SND4 outputs of the control module and the output of the 4-sounder expander.

In order to connect the sounder circuits:

- Shut down the mains supply and disconnect the terminals of the power unit to the battery.
- One by one remove the resistors (R=10K) from the sounder connecting clamps (**SND1÷SND4**) on the main module and connect them in parallel to the last sounder of each of the circuits. Connecting the sounders to outputs of 4-sounder expander is done in an analogical manner.
- Connect the sounder circuits to the **SND1÷SND4** clamps on the main module and/or on the 4-sounder expander by observing the polarity.
- Connect the battery to the power unit and apply the main power supply.





After powering up the panel should be in normal operation mode and the “Power Supply 230V” LED lights up on the front panel of MAG 8plus.

NOTE: If the **GENERAL FAULT** LED lights up on the front panel together with any of the **FAULTS** LEDs of the main module and/or the 4-sounder expander - **SND1÷SND4**, perhaps there is a problem in the connection. Check the polarity of the connection to the terminal of the main module of the panel, as well as the connection to the 4-sounder expander.

5. SYSTEM PROGRAMMING

5.1 Sounder Delay

This is an option for setting a delay on the Sounders activation when the panel enters “Fire” mode. The indication on the front panel - the **FIRE** LED, however, will light up immediately in case of a fire event, regardless of whether a delay has been set to enable the sounders. After the programmed delay period expires, during which the user can possibly find out the cause for the alarm event, the panel enables the sounders. The sounders can be silenced by pressing the **SILENCE ALARM**  (see item 6.2) on the front panel.

In case of a false fire alarm the user must press the **RESET**  button to return to normal working mode.

In order to program MAG 8plus for Sounder Delay over an interval between 1 and 10 minutes:

- Examine the Table of Instructions for programming sounder delay, shown on Figure 10.
- Depending on the selected time delay, set a jumper at the **TIME DELAY** terminals, marked in Figure 10 as 1, 2, 3, and 4.
- Press **RESET**  to introduce changes.

Example: In order to program sounder delay of 3 minutes, set jumpers on positions 1 and 2.

5.2 Double Action Mode

The purpose of introducing a DOUBLE Action mode is to avoid false alarms. Where MAG 8plus has been programmed to function in this mode, in the case of a fire signal, the panel does not alarm at once but waits for the alarm event to be repeated within a specific time interval - Figure 25. The time interval has been set by default and cannot be adjusted. For MAG 8plus it is 3 minutes.

In order to program the fire alarm panel for Double Action mode:

- Set a jumper on the **DOUBLE** terminal of the main module - Figure 10.
- Press **RESET**  to introduce changes.

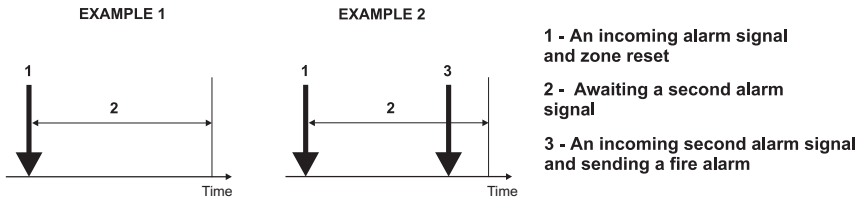

Figure 25.

EXAMPLE 1: In this case the fire panel will not activate the sounders and the signalization on the front panel because during time interval 2 no second alarm signal is generated.

EXAMPLE 2: In this case the fire panel will activate the sounders and the signalization on the front panel because during time interval 2, two alarm signals are generated.

5.3 Instant Action Mode

Where in the armed site there are zones, which need the sounders and the light indicators to be enabled instantaneously, the panel provides instant action working mode. This mode can be programmed individually for every single zone, depending on its designation. In instant action mode, in case of an alarm event occurring in the zone, the sounders are immediately enabled, *i.e. this mode is of priority by zones compared to Double Action and Sounder Delay modes.*

In DOUBLE action mode of operation, where there is NO jumper on instant action terminals of the zone expander, ONLY detectors can be connected to each zone circuit, and if a jumper has been set - that allows connecting both detectors and call points.

In order to program Instant Action mode for a selected zone:

- Set a jumper on the terminal that corresponds to the number of the zone - Figure 13.
- Press **RESET**  to introduce changes.

Example: If there are call points connected in ZONE 1, for the system to function properly there must be a jumper at its zone expander at z1 position.

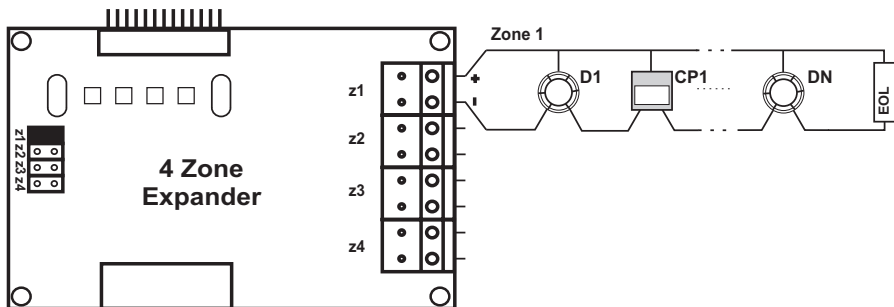



Figure 26. Example for Instant Action Mode Programming.

5.4 Master Panel Mode

When connecting two MAG 8plus panels in a common system, the first must be programmed as Master and the second as Slave.

In order to program the Master Panel mode:

- Set a jumper on the **Master** position of the main module - Figure 10.
- Press **RESET**  to introduce changes.

The connection between the Master Panel and the MR8 module relays is described in item 4.1, and the connection between the Master Panel and the Slave - in item 4.2.

5.5 Repeater Panel Mode

In order to program the Repeater Panel mode:

- Set a jumper on the **Slave** position of the main panel module - Figure 10.
- Press **RESET**  to introduce changes.

The connection between the Master Panel and the Slave is described in item 4.2.

5.6 Single Panel Mode

No jumper is set on the Master or Slave position in Single Panel Mode of the MAG 8plus.

In order to program the Single Panel mode:

- Check whether there are jumpers set on the **Master** or **Slave** position. Remove them if any.
- Press **RESET**  to introduce changes.

6. OPERATION INSTRUCTIONS

6.1 Initial Start-Up of MAG 8Plus

The panel is enabled by supplying main and stand-by power supply. An initial start-up procedure will begin to execute, which runs as follows:

1. For about 2 seconds all LEDs will light up; it is possible for a sound signal to be activated.
2. All LEDs light up for 1 second - on the main panel (except **uPFault**) and for the zone or sounder expanders (the dichromatic LEDs of the zone/ sounder expanders light up in orange). The sound signalisation is activated.
3. For about 5 seconds the following LEDs light up:
 - On the main module - all except **uPFault**;
 - On the 4-zone expanders - the LEDs of zones programmed in Instant Action mode (i.e. with a set jumper) light up in orange, and all the rest - in red;
 - On the 4-sounder expanders - the Fault LED (**SND1 - SND4**).
4. The following LEDs light up for 1 second:
 - On the main panel - all except **uPFault** and **Fire**;
 - On the 4-zone expanders - all LEDs are lit off;
 - On the 4-sounder expanders - the Fault LED (**SND1 - SND4**).

At the end of the initial start-up procedure only the **POWER SUPPLY 230V** LED lights on. All other LEDs have to be lit off.

The Fire Alarm panel is in **Normal Operating mode**.

6.2 Front Panel

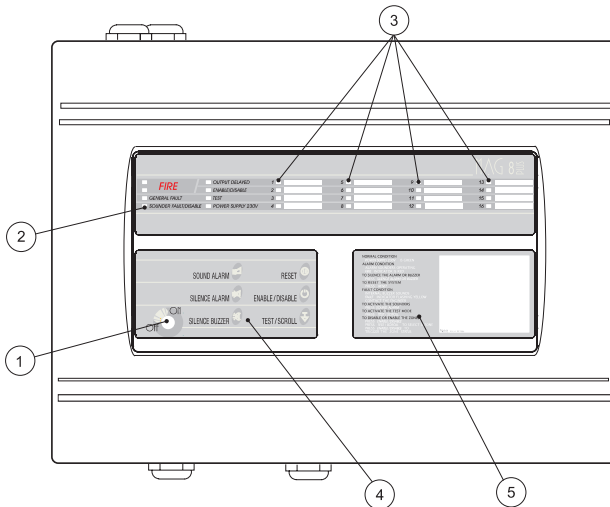

① - Switch for changing over between Access Levels 1 and 2. In **OFF** position (**Access Level 1**) only the **SILENCE BUZZER** button is active and in **ON** position (**Access Level 2**) all buttons are active.







② - Operation modes LED indication.

③ - LED indication on zone status.

④ - Control buttons.

⑤ - Instructions for working with the fire panel.





6.3 Buttons

Button	Description
SOUND ALARM 	Activating sounders.
SILENCE ALARM 	Deactivating sounders.
SILENCE BUZZER 	Deactivating the internal buzzer.
RESET 	Initializing of the start-up procedure. Confirming the introduced changes.
ENABLE / DISABLE 	Enabling / Disabling of zones / sounders.
TEST / SCROLL 	Test Mode; scroll forward zones.

6.4 LED Indication

LED	Description
FIRE (two red)	<i>Fire in the premises.</i>
GENERAL FAULT (yellow)	<i>Main Fault indicator.</i>
SOUNDER FAULT/DISABLE (yellow)	<i>Lights permanently at disabled sounders. Blinks at trouble in the sounder circuit.</i>
OUTPUT DELAY (yellow)	<i>Lights permanently at programmed outputs time delay (a jumper is set on the TIME DELAY terminal).</i>
ENABLE/DISABLE (yellow)	<i>Lights permanently at disabled zones/sounders. Blinks during enabling/disabling of zones or sounders.</i>
TEST (yellow)	<i>Blinks during "One Man" Test of a zone.</i>
POWER SUPPLY 230V (green)	<i>Blinks permanently in normal operating mode, indicates presence of main power supply 230V.</i>
LED 1- 16 (yellow-red)	<i>Zone indication. Lights up in red at Fire in the zone. Lights up in yellow at disabled zone. Blinks in yellow: - 1 blink per second at trouble in the zone; - 2 blinks per second at "One Man" Test and disabling of zones.</i>

6.5 Sound Signal





- **Short beeps** - After pressing the **RESET**  and upon the initial start-up of the panel
- **Continuous beep** - Fire and/ or Fault status. The signal can be stopped by pressing the **SILENCE BUZZER**  button, but the LED indication remains.
- **Interrupted beep** - After pressing the **ENABLE/DISABLE**  button to enable/disable zones/sounders and the **TEST/SCROLL**  button to access “One Man” test mode of zones. The signal can be stopped by pressing the **SILENCE BUZZER**  button, but the LED indication remains.

6.6 Service Modes

Zone Enable / Disable

Each zone of MAG 8plus can be enabled or disabled.

To disable a zone:

- Press **ENABLE/DISABLE**  button:
- Press **TEST/SCROLL**  button, until you reach the zone which has to be disabled:
- Press **ENABLE/DISABLE**  button:
- Press **RESET**  button:

DISABLE/ ENABLE LED blinks.





*The **ZONE 1** LED blinks in yellow (2 blinks per second) if **ZONE 1** is enabled and lights permanently if **ZONE 1** is disabled.*

The respective zone LED blinks in yellow (2 blinks per second).

The LED of the disabled zone lights permanently in yellow.

*That will run the procedure for initial start-up of the panel (item 6.1).
At this point the zone is disabled.*

To enable a zone:

- Press **ENABLE/DISABLE**  button:
- Press **TEST/SCROLL**  button until you reach the disabled zone:
- Press **ENABLE/DISABLE**  button:
- Press **RESET**  button:

DISABLE/ ENABLE LED blinks.

*The **ZONE 1** LED blinks in yellow (2 blinks per second) if **ZONE 1** is enabled and lights permanently if **ZONE 1** is disabled.*





The LED of the disabled zone lights permanently in yellow.

The zone LED will start blinking in yellow (2 blinks per second).

*That will initialize the start-up procedure and introduce the changes (item 6.1).
At this point the zone is enabled.*





Sounders Enable/Disable

To disable the sounders:

- Press **ENABLE/DISABLE**  button:
- Press **TEST/SCROLL**  button until you reach the last zone in the system - 4, 8, 12 or 16.
- Press **TEST/SCROLL**  button once again:
- Press **ENABLE/DISABLE**  button:
- Press **RESET**  button to exit the sounder disabling mode:

You can exit the sounder disabling mode also by pressing the **TEST/SCROLL**  button, as in that case the procedure for initial start-up will not run.

To enable the sounders:

- Press **ENABLE/DISABLE**  button:
- Press **TEST/SCROLL**  button until you reach the last zone in the system - 4, 8, 12 or 16.
- Press **TEST/SCROLL**  button once again:
- Press **ENABLE/DISABLE**  button:
- Press **RESET**  button to exit the sounder enabling mode:

You can exit the sounder enabling mode also by pressing the **TEST/SCROLL**  button, as in that case the procedure for initial start-up will not run.

DISABLE/ ENABLE LED blinks.

The **ZONE 1 LED** blinks in yellow (2 blinks per second) if **ZONE 1** is enabled and lights permanently if **ZONE 1** is disabled.

The **SOUNDER FAULT/ DISABLE LED** will start blinking.

The **SOUNDER FAULT/ DISABLE** lights up permanently.

That will initialize the start-up procedure and introduce the changes (item 6.1). At this point the sounders are disabled.

DISABLE/ ENABLE LED blinks.

The **ZONE 1 LED** blinks in yellow (2 blinks per second) if **ZONE 1** is enabled and lights permanently if **ZONE 1** is disabled.

The **SOUNDER FAULT/ DISABLE LED** lights up permanently in yellow.

The **SOUNDER FAULT/ DISABLE** will start blinking.

That will initialize the start-up procedure and introduce the changes (item 6.1). At this point the sounders are enabled.

“One Man” Test

The “One Man” Test mode gives the installer the possibility to test the efficiency of the system - whether the detectors react to smoke, heat, etc.

To “One Man” Test a zone:

- Press **TEST/SCROLL**  button:

TEST LED will start blinking.

*The **ZONE 1** LED blinks in yellow (2 blinks per second).*

ZONE 1 is in test mode.

Test a detector from this zone whether it react to smoke, heat, etc.

MAG 8plus will activate the sounders for about 2 seconds to confirm the provoked fire alarm.

- Press **TEST/SCROLL**  button to continue

with the system testing:

TEST LED will continue blinking.



*The **ZONE 1** LED lights out (the zone is not longer in test mode).*

*The **ZONE 2** LED blinks in yellow (2 blinks per second).*

ZONE 2 is in test mode.

Test a detector from this zone whether it react to smoke, heat, etc.

MAG 8plus will activate the sounders for about 2 seconds to confirm the provoked fire alarm.

Continue the system testing by pressing the **TEST/SCROLL**  button. The exit from the “One Man” Test mode is automatic after the end of the test procedure in the last zone, or at any time by pressing **RESET**  button.



**A sound signalization is activated at every Service Mode entering .
The signalization is deactivated by pressing **SILENCE BUZZER**  button.**

7. INDICATION

7.1 Faults Indication

Indication on the front panel	Indication on the control module	Fault description
GENERAL FAULT + blinking in yellow (1 blink per second) LED of the zone, where the fault is occurred.*	-	- Zone fault - open or short circuit. - Detector head removed.
GENERAL FAULT On + blinking SOUNDER FAULT/ DISABLE	LED SND1, SND2, SND3 or SND4 , depending on the number of the circuit.**	Sounder circuit fault - open or short circuit.
GENERAL FAULT On + POWER SUPPLY 230V Off	AC LED lights permanently.	Mains supply loss.
GENERAL FAULT On + POWER SUPPLY 230V On	AC LED blinking.	Battery charging fault.
GENERAL FAULT	BATT LOW/LOST LED lights permanently.	Battery loss.
GENERAL FAULT	BATT LOW/LOST LED blinking.	Low battery charge level.
GENERAL FAULT	RPT LED***	- No connection with the Repeater panel. - Repeater fault.
GENERAL FAULT	AUX LED	Auxiliary supply fault.
GENERAL FAULT	EARTH LED	Short circuit to earth.
GENERAL FAULT	uPFAULT LED	Processor fault.

* It is possible for a fault to arise simultaneously in several zones - the LEDs of the zones with fault will blink.

** Where the fault has occurred in the sounder circuit of the expander, the **SND1, SND2, SND3** or **SND4** LEDs of the specific module, depending of the number of the circuit.







*** Only in **Master** or **Slave** modes.

The fuses used in the system are resettable (PTC) except the one for the main power supply. In case of a overload condition the PTCs will reset themselves - the **GENERAL FAULT** LED lights on. After the PTCs resetting the panel shall automatically return to **NORMAL MODE**.



NOTE: The fault indication does not show immediately. There is a delay in reporting depending on the type of the fault. After all faults are corrected the panel automatically returns to NORMAL MODE.

7.2 Indication of the Operation Modes

Operation Mode	LED Indication	Sound Signalization
Normal Mode	The POWER SUPPLY 230V green LED lights on the front panel.	-
FIRE A FIRE relay is activated.	<ul style="list-style-type: none"> The two red FIRE LEDs light up simultaneously - the FIRE LED and the zone/zones LED (also in red) where the alarm occurred. The LEDs will remain lit even after the SILENCE BUZZER  button has been pressed. 	<ul style="list-style-type: none"> The sounders are activated. They can be disabled by pressing the SILENCE ALARM  button and can then be enabled by pressing the SOUND ALARM . The internal buzzer is activated. It is disabled by pressing the SILENCE BUZZER  button.
FAULT A FAULT relay is activated.	<ul style="list-style-type: none"> The GENERAL FAULT yellow LED and the fault LED according to the Table in item 7.1 light up simultaneously. 	<ul style="list-style-type: none"> The internal buzzer is activated. It is disabled by pressing the SILENCE BUZZER .
TEST Tests the system for proper operational efficiency	<ul style="list-style-type: none"> The two yellow LEDs blink simultaneously - the TEST LED and the zone LED (also in yellow, 2 blinks per second) where the test is conducted. 	<ul style="list-style-type: none"> The internal buzzer is activated. It is disabled by pressing the SILENCE BUZZER .
DISABLE Disabled zones and/or sounders.	<ul style="list-style-type: none"> The ENABLE/DISABLE yellow LED is lit on. The respective zone LEDs light up in yellow to indicate disabled zones. The yellow SOUNDER FAULT/DISABLE LED lights up to indicate disabled sounders. 	-

GENERAL CONNECTION CIRCUIT OF MAG 8Plus

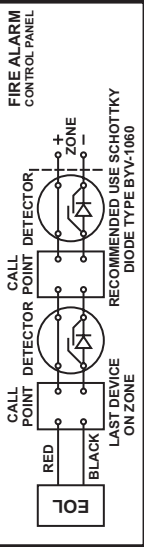

Up to 32 conventional detectors, with consumption < 200µA at normal state and unlimited number of manual call points.

ZONE NUMBERS: 1, 2, 3, 4, 5 ... 16
SOUNDER NUMBERS: 1, 2, 3 ... (16 - ZONE NUMBERS)

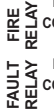
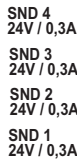

MAG8plus MAIN BOARD
EN54-2; 1997+AC; 1999+A1; 2006
EN54-4; 1997+AC; 1999+A1; 2002+A2; 2006

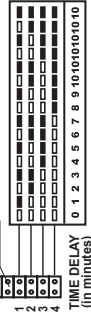

POWER

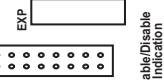

Expander 4 Zones / 4 Sounders

Expander 4 Zones / 4 Sounders

Expander 4 Zones / 4 Sounders

Expander 4 Zones / 4 Sounders

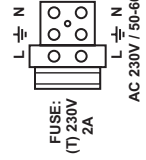
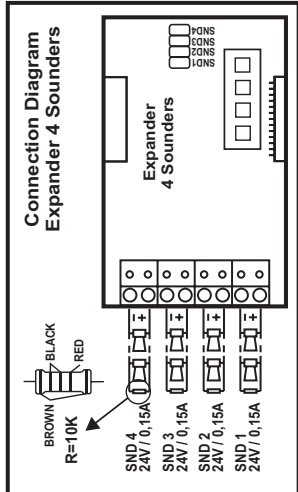
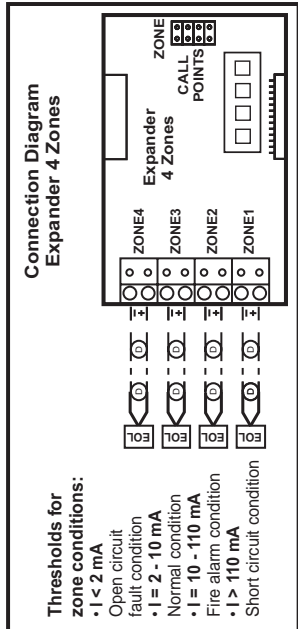

FIRE ALARM RECORD

Installation address.....

Contact person:.....

Telephone:.....

Fax:

Date completed:.....

Commissioned by.....

Contract reference:

Service intervals: Monthly / Quarterly / Half yearly / Annually.

ZONE №	LOCATION	DETECTOR TYPE and QUANTITY PER ZONE				
		Ion	Ph	RoR	F/T	CP
1						
2						
3						
4						
5						
6						
7						
8						
9						
10						
11						
12						
13						
14						
15						
16						
TOTAL:						

Ion - Ionisation sensor

Ph - Photoelectric sensor

RoR - Rate of Rise sensor

F/T - Fixed Temperature sensor

CP - Call Point

System installed by:





















Telephone/Fax:

SERVICE RECORD

Date Visit Completed		Zones Tested	Faults Rectified	Signature of Engineer	Next Due
	1 2 3 4 5 6 7				
	8 9 10 11 12		Name:		
	13 14 15 16				
	1 2 3 4 5 6 7				
	8 9 10 11 12		Name:		
	13 14 15 16				
	1 2 3 4 5 6 7				
	8 9 10 11 12		Name:		
	13 14 15 16				

FIRE ALARM EVENT LOG

Date	Time	Fire	Zone number	Fault yes/no and Type	Action Taken	Name

MAG 8plus Spare Parts Kit			
1.		Resistor 10K $\pm 1\%$, 0,25W	5
2.		Anchors 6x30mm	4
3.		Fuse 2A, T-Type 5x20mm	1
4.		Self tapping screw M4,2x35 cross slot DIN7981	4
5.		Jumper	2
6.		Cable tie 2,5/160mm	2
7.		Lightpipe for indication	5
8.		EOL - module	9
9.		Plastic cap	21
4-Zone Expander MAG 8plus Spare Parts Kit			
10.		Screw M3x6 DIN7985	4
11.		Lightpipe for indication	1
12.		EOL - module	4
13.		Jumper	1
4-Sounder Expander MAG 8plus Spare Parts Kit			
14.		Screw M3x6 DIN7985	4
15.		Lightpipe for indication	1
16.		Resistor 10K $\pm 1\%$, 0,25W	4
Hanger for Flush Mounting Spare Parts Kit			
17.		Screw M4x40 cross slot DIN7985	4
18.		Washer M4 DIN522	4
19.		Screw M4x30 cross slot DIN965	2
20.		Hanger for flush mounting, 300x41x18mm	2



Distributor:

www.teletek-electronics.com

Address: 14A Srebarna Str., 1407 Sofia, Bulgaria

Tel: (+359 2) 9694 700, Fax: (+359 2) 962 52 13

e-mail: info@teletek-electronics.bg